



Series
TCX

SIZE 22 FRONT RELEASE, FRONT REMOVABLE
PC POST SOCKET CONTACT

Issue:
8 JULY 99

Page
1 / 1

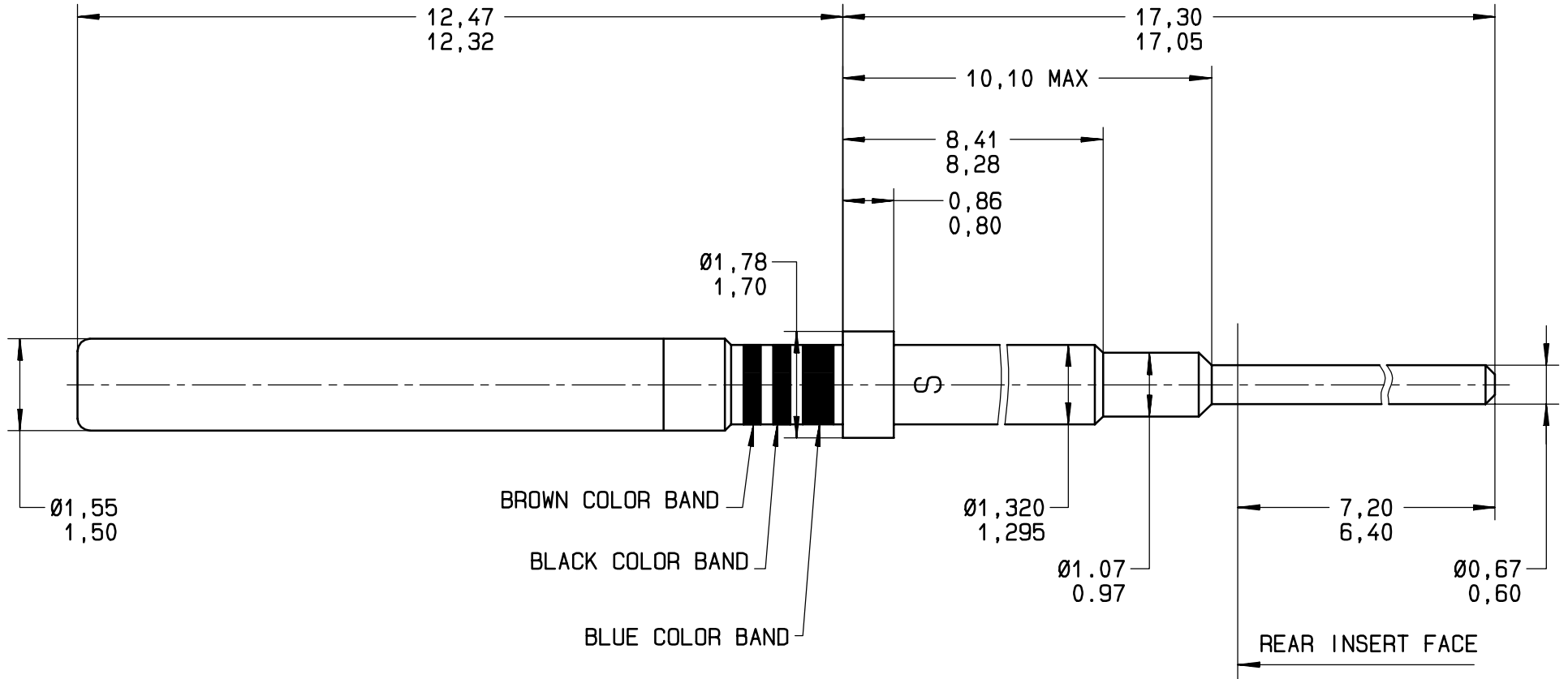

MATERIAL:

BODY: BERYLLIUM COPPER PER ASTM-B-196
PROTECTIVE SLEEVE: STAINLESS STEEL PER AISI 305

FINISH:

BODY: .00005 INCH OF GOLD PER MIL-G-45204 TYPE I OR II, GRADE C OR D, CLASS 1 OVER NICKEL PER QQ-N-290
PROTECTIVE SLEEVE: PASSIVATED PER QQ-P-35

INSERTION/EXTRACTION TOOL: RADIALL 282500

This information is given as an indication. In the continual goal to improve our products, we reserve the right to make any modifications judged necessary.

4112-9610

CREATION				
PEN:				
NOM: ARNAULT				
DATE: 8 JULY 99				
APPR.:	Issue	Revisions	Name	Approved